

M12 female 90° A-cod. with cable

PUR 4x0.34 or UL/CSA+robot+drag ch. 1m

Female 90°

M12, 4-pole

Zinc die casting, save-cover coated

Suitable for VASS6 automotive body construction. Complies with MgU-I-B09-41.

Art-No. 7005 - M12 Lite - (plastic hexagonal screw) on request

Fulfills the requirements of MgU-I-B09-41 for the body construction industry.

Plastic housings with good resistance against chemicals and oils.

The resistance to aggressive media should be individually tested for your application. Further details on request.

Further cable lengths on request.

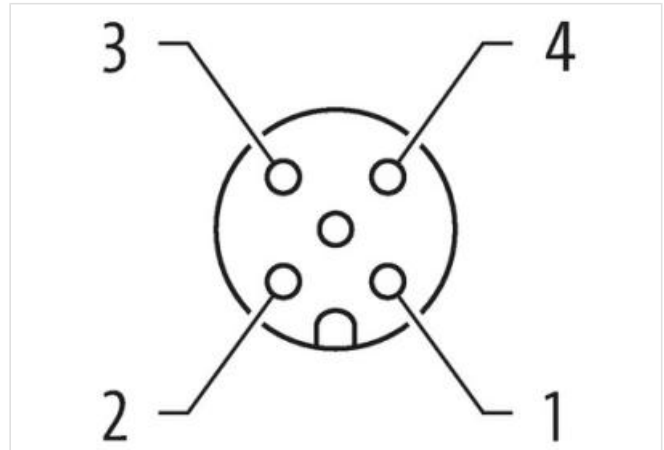
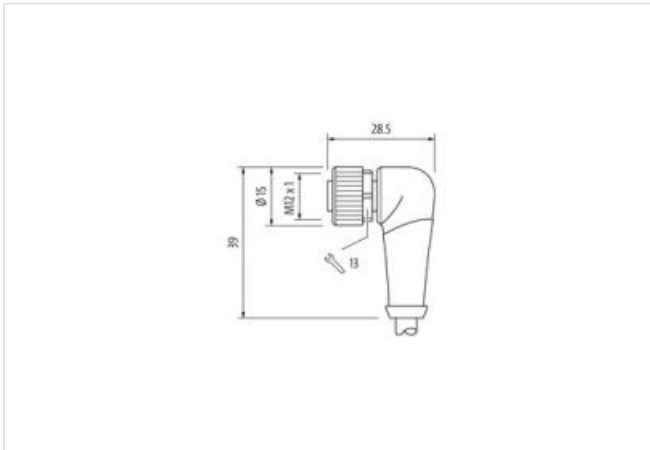
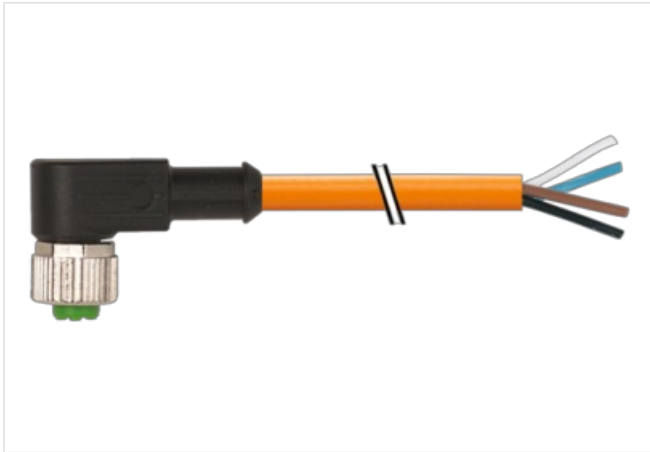
[Link to Product](#)**Illustration**

Product may differ from Image



Cable length

1 m

Side 1	
Tightening torque	0,6 Nm
Mounting method	inserted, screwed
Coating contact	gold plated
Family construction form	M12
Material contact	Copper alloy
Material	PUR
No. of poles	4
Width across flats	SW13
Commercial data	
ECLASS-6.0	27279218
ECLASS-6.1	27279218
ECLASS-7.0	27279218
ECLASS-8.0	27279218
ECLASS-9.0	27060311
ECLASS-10.1	27060311
ECLASS-11.1	27060311
ECLASS-12.0	27060311
ETIM-5.0	EC001855
customs tariff number	85444290
GTIN	4048879487535
Packaging unit	1
Electrical data Supply	
Operating voltage AC max.	250 V
Operating voltage DC max.	250 V
Installation Connection	
Mounting set	M12 x 1
Device protection Electrical	
Pollution Degree	3
Rated surge voltage	2,5 kV
Material group (IEC 60664-1)	I
Mechanical data Material data	
Coating of fitting	nickel plated
Material screw connection	Zinc die-casting
Environmental characteristics Climatic	
Operating temperature min.	-25 °C
Operating temperature max.	85 °C
Additional condition temperature range	depending on cable quality
Important installation notes	
Note on strain relief	Protect the connectors by suitable measures from mechanical loads, e.g. by the usage of cable ties.
Note on bending radius	Attention: Observe the permissible bending radii when laying cables, as the IP protection class can be endangered by excessive bending forces.
Installation Cable	
wire arrangement	brown, black, blue, white
Cable identification	846
Cable Type	5
Jacket Color	orange
Type of Certificate	cURus
Approvals	cURus (AWM-Style 20549/10493), CE compliant, VASS 6 compliant, according to MgU-I-B09-41 (March 2021)
Amount stranding	1
Stranding	4 wires twisted

wire arrangement	brown, black, blue, white
Cable weight	38,5 g/m
Material jacket	PUR
Shore hardness jacket	54 ± 5 Shore D
Freedom from ingredients (jacket)	lead-free, cadmium-free, CFC-free, halogen-free, silicone-free
Outer-diameter (jacket)	4,8 mm
Tolerance outer diameter (sheath)	± 5 %
Material wire insulation	PP
Amount wires	4
Outer diameter insulation	1,25 mm
Outer diameter tolerance core insulation	± 5 %
Shore hardness wire insulation	73 ± 5 Shore D
Ingredient freeness wire insulation	lead-free, cadmium-free, CFC-free, halogen-free, silicone-free
Amount strands (wire)	42
Diameter of single wires	0,1 mm
Conductor crosssection (wire)	0,34 mm ²
Material conductor wire	Stranded copper wire, bare
Conductor type (wire)	strand class 6
Nominal voltage AC max.	300 V
Current load capacity (standard)	to DIN VDE 0298-4
Current load capacity min. wire	4,8 A
Electrical resistance line constant wire	60 Ω/km @ 20 °C
AC withstand voltage (wire - wire)	2,5 kV @ 60 s
Power frequency withstand voltage (wire - jacket)	2,5 kV @ 60 s
Min. operating temperature (static)	-40 °C
Max. operating temperature (fixed)	80 °C / 90 °C @ 10000 h Operation
Operating temperature min. (dynamic)	-25 °C
Operating temperature max. (dynamic)	80 °C / 90 °C @ 10000 h Operation
Flame resistance	IEC 60332-2-2 UL 1581 § 1090 UL 1581 § 1100 FT2
chemical resistance	Good, application-related testing
Gasoline resistance	Good, application-related testing
Oil resistance	Good, application-related testing DIN EN 60811-404
Bending radius (fixed)	5 x Outer diameter
Bending radius (dynamic)	10 x Outer diameter
No. of bending cycles (C-track)	10 Mio. @ 25 °C
Traversing distance (C-track)	5 m @ 25 °C horizontal
Travel speed (C-track)	3,3 m/s @ 25 °C
No. of torsion cycles	1 Mio.
Torsion stress	± 360 °/m
Torsion speed	35 cycles/min