

M12 male 0° A-cod. / MSUD valve plug A-18mm

PUR 5x0.34 gy UL/CSA 4m

⚠ NOTICE ⚠**PRODUCT IS DISCONTINUED. PLEASE HAVE A LOOK AT THE ALTERNATIVE PRODUCTS.**

Form A (18 mm) – M12, male straight

24 V DC $\pm 25\%$

LED (red/green)

for pressure switches

Further cable lengths on request.

Plastic housings with good resistance against chemicals and oils.

The resistance to aggressive media should be individually tested for your application. Further details on request.

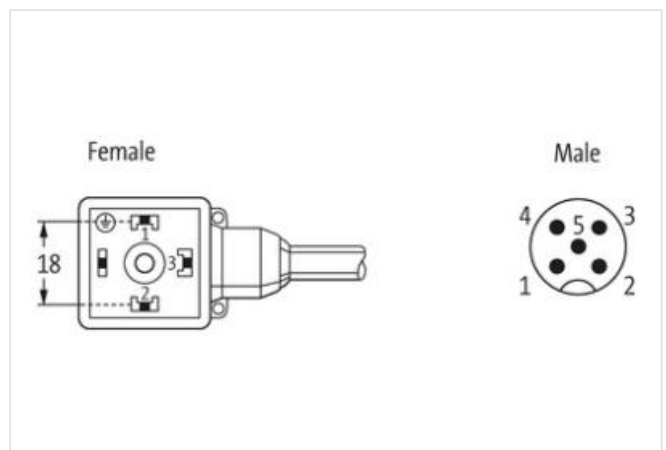
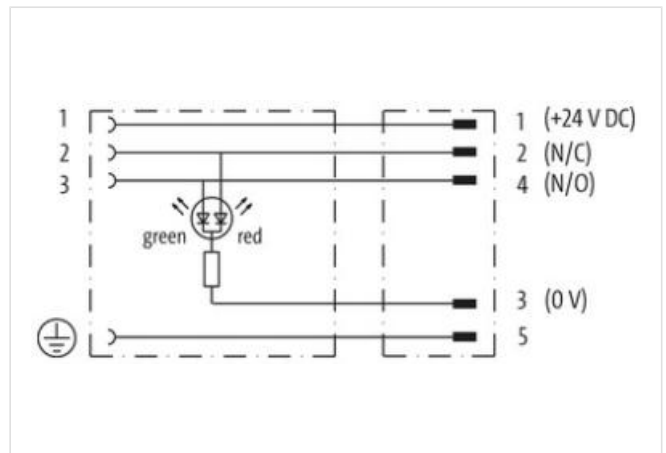
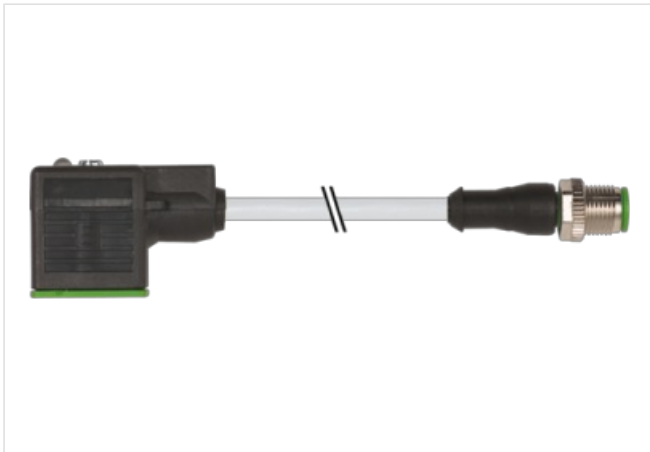
[Link til artikel](#)**Billede**

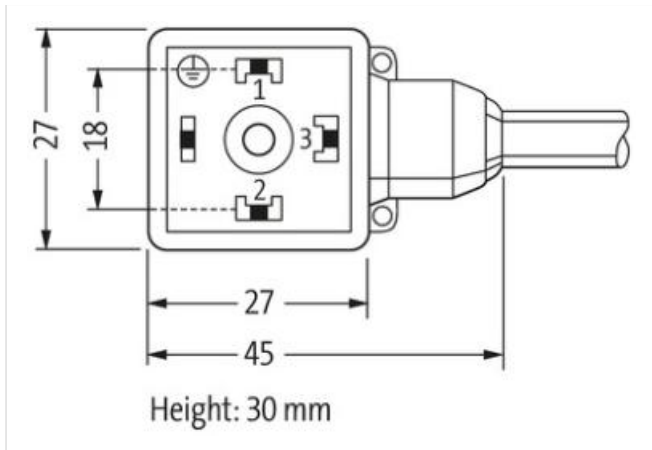

Produktet kan afvige fra billedet



Cable length 4 m

Side 1

Tightening torque 0,4 Nm
 Family construction form MSUD
 Thread M3
 Degree of protection (EN IEC 60529) IP67

Side 2

Tightening torque 0,6 Nm
 Family construction form M12
 Thread M12 x 1
 Width across flats SW13
 Degree of protection (EN IEC 60529) IP67

Commercial data

ECLASS-6.0 27279218
 ECLASS-6.1 27279218
 ECLASS-7.0 27279218
 ECLASS-8.0 27279218
 ECLASS-9.0 27060312
 ECLASS-10.1 27060312
 ECLASS-11.1 27060312
 ECLASS-12.0 27060312
 ETIM-5.0 EC001855
 customs tariff number 85444290
 GTIN 4048879386791
 Pakke-enhed 1

Electrical data | Supply

Operating voltage DC 24 V
 Operating voltage DC min. 18 V
 Operating voltage DC max. 30 V
 Current operating per contact max. 4 A

Device protection | Electrical

Additional condition protection degree inserted, screwed

Rated surge voltage 0,8 kV

Mechanical data | Material data

Color housing black
Material housing Plastic

Mechanical data | Mounting data

Mounting method inserted, screwed

Environmental characteristics | Climatic

Operating temperature min. -25 °C
Operating temperature max. 85 °C
Additional condition temperature range depending on cable quality

Cable

Cable identification	225
Cable Type	2 (PUR/PVC)
Approval (cable)	UL (AWM-Style 20549/1731), CSA; CE conform
Cable weight [g/m]	54,78 g
Material wire	Cu wire, bare
Resistor (core)	max. 57 Ω/km (20 °C)
Single wire Ø (core)	0.1 mm
Construction (core)	42× 0.1 mm (multi-strand wire class 6)
Diameter (core)	5× 0.34 mm ²
AWG	similar to AWG 22
Material wire isolation	PVC
Material property wire insulation	CFC-, cadmium-, silicone- and lead-free
Shore hardness wire isolation	43 ±5 D
Wire-Ø incl. isolation	1.25 mm ±5%
Color/numbering of wires	br, bk, bl, wh, gnye longitudinally striped
Stranding combination	5 wires twisted around central filler
Shield	no
Material jacket	PUR/PVC
Material property (jacket)	CFC-, halogen-, cadmium-, silicone- and lead-free, matt, low-adhesion, machine easy to process, abrasion-resistant, hydrolysis and microbial resistant
Shore hardness jacket	80 ±5 A (PVC-under jacket); 85 ±5 A (PUR-jacket)
Outer-Ø (jacket)	5.0 mm ±5%
Color jacket	gray
chemical resistance	good resistance to oil, gasoline and chemicals
Nominal voltage	UL 300 V AC
Test voltage	2000 V AC
Current load capacity	to DIN VDE 0298-4
Temperature range (fixed)	-30...+80 °C
Temperature range (mobile)	-5...+80 °C
Bending radius (fixed)	10× outer Ø
Bending radius (dynamic)	15× outer Ø
No. of bending cycles (C-track)	max. 2 Mio. (25 °C)
Travel speed (C-track)	max. 3.3 m/s
Acceleration (C-track)	max. 5 m/s ²