

## Valve plug MJC 90° with cable LED V2A

PUR 2x0.5 bk drag ch. 5m

Xtreme - Outdoor

Female 90°

12...24 V AC/DC

LED

Stainless steel 1.4305 (V2A)

Plastic housings with good resistance against chemicals and oils.

The resistance to aggressive media should be individually tested for your application. Further details on request.

Further cable lengths on request.

### Link to Product

#### Illustration

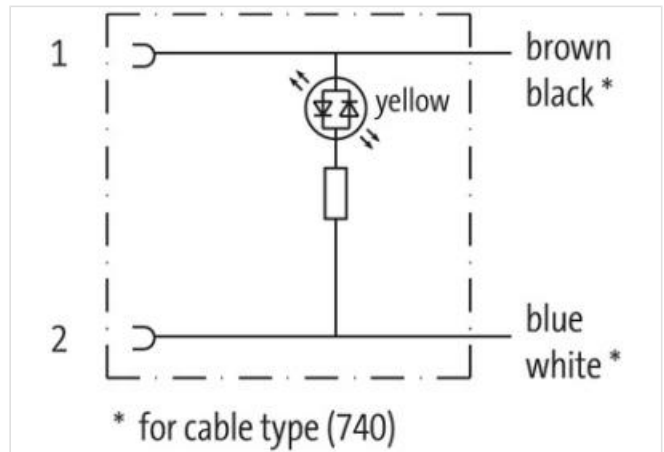

Product may differ from Image

Cable length 5 m

#### Commercial data

ECLASS-6.0	27279218
ECLASS-7.0	27279218
ECLASS-8.0	27279218
ECLASS-9.0	27060311

ECLASS-10.1	27060312
ECLASS-11.1	27060312
ECLASS-12.0	27060312
ETIM-5.0	EC001855
customs tariff number	85444290
GTIN	4048879312493
Packaging unit	1

**Electrical data | Supply**

Operating voltage AC min.	12 V
Operating voltage AC max.	24 V
Operating voltage DC min.	12 V
Operating voltage DC max.	24 V
Current operating per contact max.	4 A
Current consumption max.	12 mA

**Diagnostics**

Status indication LED	yellow
-----------------------	--------

**Device protection | Electrical**

Degree of protection (EN IEC 60529)	IP65
Additional condition protection degree	inserted, locked

**Device protection | Media**

Flame resistance	flame retardant
------------------	-----------------

**Mechanical data | Material data**

Color housing	black
Material housing	Plastic
Locking material	Stainless steel 1.4305 (V2A)

**Environmental characteristics | Climatic**

Operating temperature min.	-25 °C
Operating temperature max.	85 °C
Additional condition temperature range	depending on cable quality

**Important installation notes**

Note on strain relief	Protect the connectors by suitable measures from mechanical loads, e.g. by the usage of cable ties.
Note on bending radius	<b>Attention:</b> Observe the permissible bending radii when laying cables, as the IP protection class can be endangered by excessive bending forces.

**Installation | Cable**

wire arrangement	black, white
Cable identification	740
Jacket Color	black
Amount stranding	1
Stranding	2 wires twisted
wire arrangement	black, white
Cable weight	36,3 g/m
Material jacket	PUR
Shore hardness jacket	85 Shore A
Freedom from ingredients (jacket)	lead-free, cadmium-free, CFC-free, halogen-free
Outer-diameter (jacket)	5 mm
Tolerance outer diameter (sheath)	± 5 %
Material wire insulation	TPE-E
Amount wires	2
Outer diameter insulation	1,5 mm
Outer diameter tolerance core insulation	± 5 %
Shore hardness wire insulation	70 Shore A

Ingredient freeness wire insulation	lead-free, CFC-free, halogen-free
Amount strands (wire)	64
Diameter of single wires	0,1 mm
Conductor crosssection (wire)	0,5 mm <sup>2</sup>
Material conductor wire	Stranded copper wire, bare
Conductor type (wire)	strand class 6
Max. rated voltage (conductor - conductor)	500 V
Max. rated voltage (conductor - ground)	300 V
Current load capacity (standard)	to DIN VDE 0298-4
Current load capacity min. wire	9 A
Electrical resistance line constant wire	39 Ω/km @ 20 °C
AC withstand voltage (wire - wire)	2 kV @ 60 s
Power frequency withstand voltage (wire - jacket)	2 kV @ 60 s
Min. operating temperature (static)	-50 °C
Max. operating temperature (fixed)	90 °C
Operating temperature min. (dynamic)	-30 °C
Operating temperature max. (dynamic)	90 °C
UV resistance	DIN EN ISO 4892-2 A
Flame resistance	UL 1581 § 1100 FT2   UL 1581 § 1090   IEC 60332-2-2
chemical resistance	Good, application-related testing
Gasoline resistance	Good, application-related testing
Oil resistance	Good, application-related testing   DIN EN 60811-404
Bending radius (dynamic)	10 x Outer diameter
No. of bending cycles (C-track)	2 Mio. @ 25 °C
Traversing distance (C-track)	5 m @ 25 °C   horizontal
Travel speed (C-track)	3,3 m/s @ 25 °C